

Article number: 12704000160500

Description: KLEE-coil 704 000 160.500
M16 St. steel 1.4305

Measures

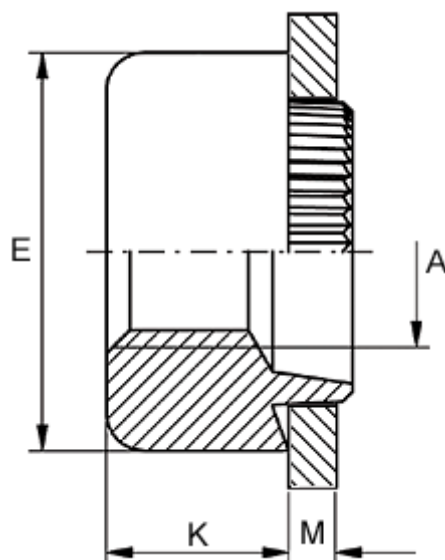

Female thread A	= M16
Height K	= 10.0
Outer diameter E	= 25.0
Plate thickness	= 0.9 to 1.0
Recommended bore diameter for extreme load	= 19.0
Recommended bore diameter for normal use	= 20.0